

STIHL[®]

STIHL KM 56 R

Instruction Manual



Contents

KombiSystem	2
Guide to Using this Manual	2
Safety Precautions and Working Techniques	3
Approved KombiTools	7
Mounting the Loop Handle	8
Carrying ring	10
Fuel	10
Fueling	12
Starting / Stopping the Engine	14
Operating Instructions	16
Cleaning the Air Filter	16
Adjusting the Carburetor	17
Spark Plug	18
Engine Running Behavior	19
Storing the Machine	19
Maintenance and Care	20
Minimize Wear and Avoid Damage	21
Main Parts	22
Specifications	23
Maintenance and Repairs	23
Disposal	24
EC Declaration of Conformity	24

Dear Customer,

Thank you for choosing a quality engineered STIHL product.

It has been built using modern production techniques and comprehensive quality assurance. Every effort has been made to ensure your satisfaction and troublefree use of the product.

Please contact your dealer or our sales company if you have any queries concerning this product.

Your



Dr. Nikolas Stihl

STIHL®

KM 56 R, KM 56 RC

KombiSystem

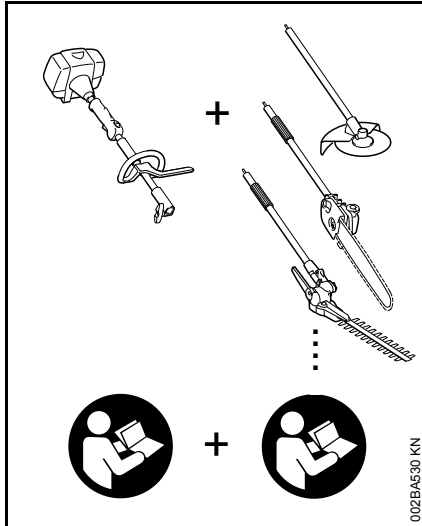

In the STIHL KombiSystem a number of different KombiEngines and KombiTools can be combined to produce a power tool. In this instruction manual the functional unit formed by the KombiEngine **and** KombiTool is referred to as the power tool.

Therefore, the separate instruction manuals for the KombiEngine and KombiTool should be used together for the power tool.

Always read and make sure you understand **both** instruction manuals before using your power tool for the first time and keep them in a safe place for future reference.

Guide to Using this Manual

Pictograms

The meanings of the pictograms attached to the machine are explained in this manual.

Depending on the model concerned, the following pictograms may be attached to your machine.

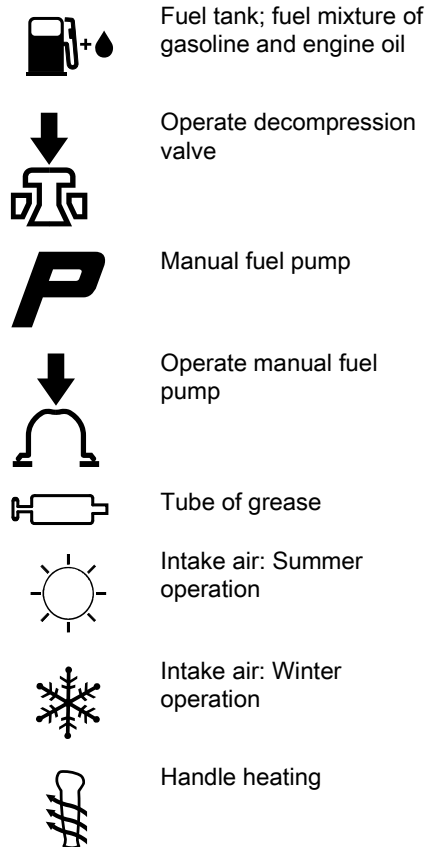

Symbols in text

WARNING

Warning where there is a risk of an accident or personal injury or serious damage to property.

NOTICE

Caution where there is a risk of damaging the machine or its individual components.

Engineering improvements

STIHL's philosophy is to continually improve all of its products. For this reason we may modify the design, engineering and appearance of our products periodically.

Therefore, some changes, modifications and improvements may not be covered in this manual.

Safety Precautions and Working Techniques



Special safety precautions must be observed when working with a power tool.



Always read and make sure you understand both instruction manuals (KombiEngine and KombiTool) before using your power tool for the first time and keep them in a safe place for future reference. Non-observance of the safety precautions may result in serious or even fatal injury.

Observe all applicable local safety regulations, standards and ordinances.

If you have not used this type of power tool before: Have your dealer or other experienced user show you how it is operated or attend a special course in its operation.

Minors should never be allowed to use a power tool.

Keep bystanders, especially children, and animals away from the work area.

When the power tool is not in use, shut it off so that it does not endanger others. Secure it against unauthorized use.

The user is responsible for avoiding injury to third parties or damage to their property.

Lend or rent your power tool only to persons who are familiar with this model and its operation – do not lend or rent your power tool without the KombiEngine and KombiTool instruction manuals.

The use of noise emitting power tools may be restricted to certain times by national or local regulations.

To operate the power tool you must be rested, in good physical condition and mental health.

If you have any condition that might be aggravated by strenuous work, check with your doctor before operating a power tool.

Persons with pacemakers only: The ignition system of your power tool produces an electromagnetic field of a very low intensity. This field may interfere with some pacemakers. STIHL recommends that persons with pacemakers consult their physician and the pacemaker manufacturer to reduce any health risk.

Do not operate the power tool if you are under the influence of any substance (drugs, alcohol) which might impair vision, dexterity or judgment.

Use your power tool only for the applications described in the instruction manual of the KombiTool you are using.

Do not use your power tool for any other purpose because of the **increased risk of accidents**.

Do not operate the KombiEngine without a properly mounted KombiTool since this may result in damage to the machine.

Only use KombiTools and accessories that are explicitly approved for this power tool by STIHL or are technically identical. It is important that you read the chapter on "Approved KombiTools". If you have any questions in this respect, consult a servicing dealer. Use only high quality tools and accessories in order to avoid the risk of accidents and damage to the machine.

STIHL recommends the use of genuine STIHL tools and accessories. They are specifically designed to match the product and meet your performance requirements.

Never attempt to modify your machine in any way since this may increase the risk of personal injury. STIHL excludes all liability for personal injury and damage to property caused while using unauthorized attachments.

Do not use a pressure washer to clean your power tool. The solid jet of water may damage parts of the power tool.

Clothing and Equipment

Wear proper protective clothing and equipment.



Avoid clothing that could get caught on branches or brush or moving parts of the machine. Do not wear a scarf, necktie or jewelry. Tie up and confine long hair (e.g. with a hair net, cap, hard hat, etc.).

See also notes on "Clothing and Equipment" in the instruction manual of the KombiTool you are using.

Transporting the Power Tool

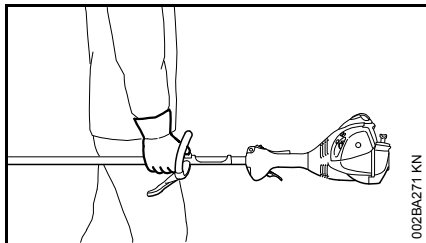

Always shut off the engine.

Transporting by vehicle: Properly secure your power tool to prevent turnover, fuel spillage and damage.

See also notes on "Transporting the Machine" in the instruction manual of the KombiTool you are using.

Fueling



Gasoline is an extremely flammable fuel. Keep clear of naked flames. Do not spill any fuel – do not smoke.

Always shut off the engine before refueling.

Do not fuel a hot engine – **fuel may spill and cause a fire.**

Open the fuel cap carefully to allow any pressure build-up in the tank to release slowly and avoid fuel spillage.

Fuel your power tool only in well-ventilated areas. If you spill fuel, wipe the machine immediately – if fuel gets on your clothing, change immediately.

Your power tool comes standard with either a screw-type or bayonet-type fuel cap.



After fueling, tighten down the screw-type fuel cap as securely as possible.



After fueling, insert the fuel cap with hinged grip (bayonet-type cap) correctly in the opening, turn it clockwise as far as stop and fold the grip down.

This reduces the risk of unit vibrations causing the fuel cap to loosen or come off and spill quantities of fuel.



To reduce the risk of serious or fatal burn injuries, check for fuel leakage. If fuel leakage is found, do not start or run the engine until leak is fixed.

Before Starting

Check that your power tool is properly assembled and in good condition – refer to appropriate chapters in the instruction manuals.

- Check the fuel system for leaks, paying special attention to visible parts such as the tank cap, hose connections and the manual fuel pump (on machines so equipped). If

there are any leaks or damage, do not start the engine – **risk of fire.** Have your machine repaired by a servicing dealer before using it again.

- Use only an approved combination of cutting attachment, deflector, handle and harness. All parts must be assembled properly and securely.
- The stop switch must move easily to 0.
- Check smooth action of choke knob, throttle trigger lockout and throttle trigger – the throttle trigger must return automatically to the idle position. The choke lever must spring back from the  and  positions to the run position I when the throttle trigger lockout and throttle trigger are squeezed.
- Check that the spark plug boot is secure – a loose boot may cause arcing that could ignite combustible fumes **and cause a fire.**
- Never attempt to modify the controls or safety devices in any way.
- Keep the handles dry and clean – free from oil and dirt – for safe control of the power tool.
- Adjust the harness and handle(s) to suit your height and reach.

To reduce the risk of accidents, do not operate your power tool if it is damaged or not properly assembled.

If you use a shoulder strap or full harness: Practice removing and putting down the machine as you would in an

emergency. To avoid damage, do not throw the machine to the ground when practicing.

See also notes on "Before Starting" in the instruction manual of the KombiTool you are using.

Start the engine.

Start the engine at least 3 meters from the fueling spot, outdoors only.

Place the power tool on firm ground in an open area. Make sure you have good balance and secure footing. Hold the power tool securely. The attachment must be clear of the ground and all other obstructions because it may begin to run when the engine starts.

To reduce the risk of injury, avoid contact with the attachment.

Do not drop start the power tool – start the engine as described in the instruction manual. Note that the attachment continues to run for a short period after you let go of the throttle trigger – flywheel effect.

Check idle speed setting: The attachment must be stationary when the engine is idling with the throttle trigger released.

To reduce the risk of fire, keep hot exhaust gases and hot muffler away from easily combustible materials (e.g. wood chips, bark, dry grass, fuel).

See also notes on "Starting the Engine" in the instruction manual of the KombiTool you are using.

Holding and Controlling the Power Tool

Always hold the power tool firmly with both hands on the handles.

Make sure you always have good balance and secure footing.

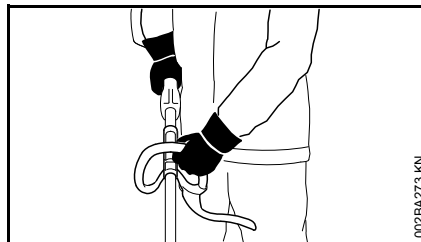

Left hand on loop handle, right hand on control handle, even if you are left-handed.

During Operation

In the event of impending danger or in an emergency, switch off the engine immediately – move the stop switch in the direction of 0.

The correct engine idle speed is important to ensure that the attachment stops moving when you let go of the throttle trigger. If the attachment continues to run when the engine is idling, have your dealer check your machine and make proper adjustments or repairs. Check and correct the idle speed setting regularly. STIHL recommends an authorized STIHL servicing dealer.

Be particularly alert and cautious when wearing hearing protection because your ability to hear warnings (shouts, alarms, etc.) is restricted.

To reduce the risk of accidents, take a break in good time to avoid tiredness or exhaustion.

Work calmly and carefully – in daylight conditions and only when visibility is good. Stay alert so as not to endanger others.

Use your power tool only in the areas specified in the KombiTool instruction manual.



Your power tool produces toxic exhaust fumes as soon as the engine is running. These fumes may be colorless and odorless and contain unburned hydrocarbons and benzol. Never run the engine indoors or in poorly ventilated locations, even if your model is equipped with a catalytic converter.

To reduce the risk of serious or fatal injury from breathing toxic fumes, ensure proper ventilation when working in trenches, hollows or other confined locations.

To reduce the risk of accidents, stop work immediately in the event of nausea, headache, visual disturbances (e.g. reduced field of vision), problems with hearing, dizziness, deterioration in ability to concentrate. Apart from other possibilities, these symptoms may be caused by an excessively high concentration of exhaust gases in the work area.

Operate your power tool so that it produces a minimum of noise and emissions – do not run the engine unnecessarily, accelerate the engine only when working.

To reduce the risk of fire, do not smoke while operating or standing near your power tool. Note that combustible fuel vapor may escape from the fuel system.

The dusts, vapor and smoke produced during operation may be dangerous to health. If the work area is very dusty or smoky, wear a respirator.

If your power tool is subjected to unusually high loads for which it was not designed (e.g. heavy impact or a fall), always check that it is in good condition before continuing work – see also "Before Starting". Check the fuel system in particular for leaks and make sure the safety devices are working properly. Do not continue operating your power tool if it is damaged. In case of doubt, consult your servicing dealer.

Do not operate your power tool with the choke lever in the warm start position  – the engine speed cannot be controlled in this position.

Before leaving the power tool unattended: Shut off the engine.

To reduce the risk of injury, always shut off the engine before changing the KombiTool or attachment.

Vibrations

Prolonged use of the power tool may result in vibration-induced circulation problems in the hands (whitefinger disease).

No general recommendation can be given for the length of usage because it depends on several factors.

The period of usage is prolonged by:

- Hand protection (wearing warm gloves)
- Work breaks

The period of usage is shortened by:

- Any personal tendency to suffer from poor circulation (symptoms: frequently cold fingers, tingling sensations).
- Low outside temperatures.
- The force with which the handles are held (a tight grip restricts circulation).

Continual and regular users should monitor closely the condition of their hands and fingers. If any of the above symptoms appear (e.g. tingling sensation in fingers), seek medical advice.

Maintenance and Repairs

Service the machine regularly. Do not attempt any maintenance or repair work not described in the instruction manual. Have all other work performed by a servicing dealer.

STIHL recommends that you have servicing and repair work carried out exclusively by an authorized STIHL servicing dealer. STIHL dealers are regularly given the opportunity to attend training courses and are supplied with the necessary technical information.

Only use high-quality replacement parts in order to avoid the risk of accidents and damage to the machine. If you have any questions in this respect, consult a servicing dealer.

STIHL recommends the use of genuine STIHL replacement parts. These parts are specifically designed to match your machine model and meet your performance requirements.

To reduce **the risk of injury** from unintentional engine startup, **always shut off the engine and disconnect the spark plug boot** before performing any repairs, maintenance or cleaning work. – Exception: Carburetor and idle speed adjustments.

Do not turn the engine over on the starter with the spark plug boot or spark plug removed since there is otherwise a **risk of fire** from uncontained sparking.

To reduce the **risk of fire**, do not service or store your machine near open flames.

Check the fuel filler cap for leaks at regular intervals.

Use only a spark plug of the type approved by STIHL and make sure it is in good condition – see "Specifications".

Inspect the ignition lead (insulation in good condition, secure connection).

Check the condition of the muffler.

To reduce the **risk of fire and damage to hearing**, do not operate your machine if the muffler is damaged or missing.

Do not touch a hot muffler since **burn injury** will result.

Approved KombiTools

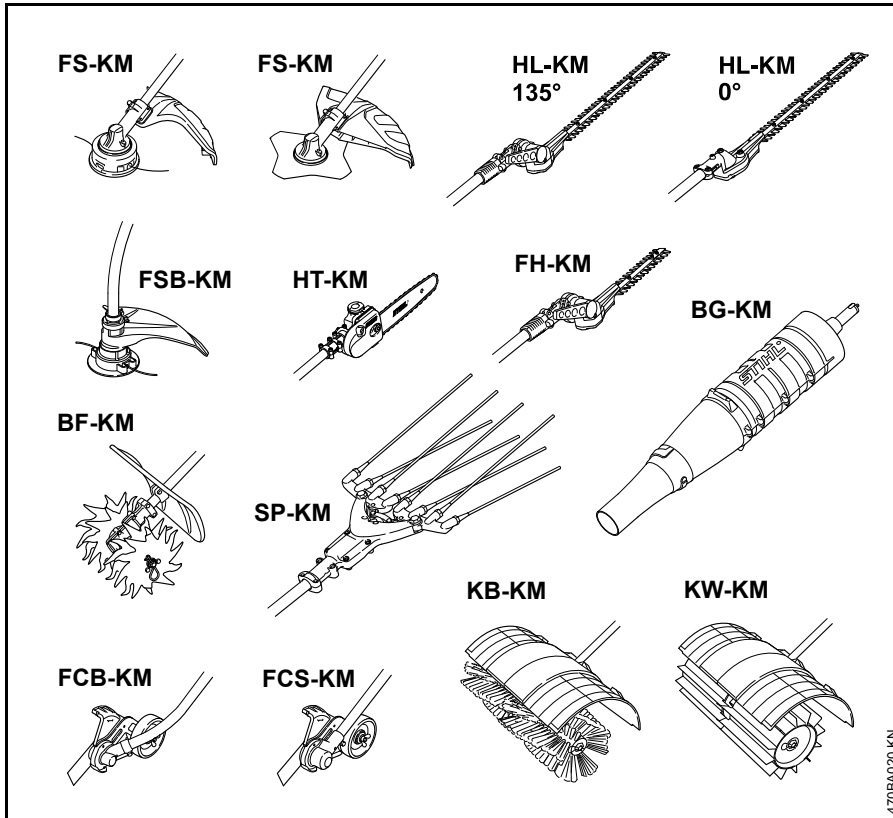

The following STIHL KombiTools may be mounted on the KombiEngine:

KombiTool	Application
FS-KM	Trimmer with mowing head
FS-KM ¹⁾	Trimmer with grass cutting blade
FSB-KM	Trimmer with mowing head
HL-KM 135°	Hedge trimmer, adjustable
HL-KM 0°	Long reach hedge trimmer
FH-KM 135°	Power scythe
BG-KM	Blower
HT-KM	Pole pruner
BF-KM	Pick tines
FCB-KM	Edger
FCS-KM	Edger
SP-KM	Special harvester
KB-KM	Bristle brush
KW-KM	PowerSweep

¹⁾ the barrier bar on the loop handle supplied with the machine must be used – see also "Mounting the Loop Handle"

Mounting the Loop Handle

The loop handle comes in two different versions.

Version A

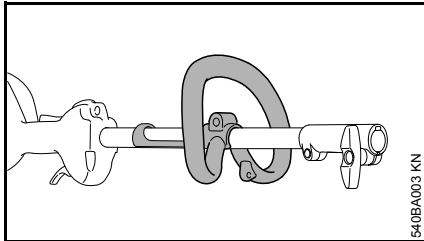

A factory-new machine comes with the loop handle already mounted.

Using the Barrier Bar

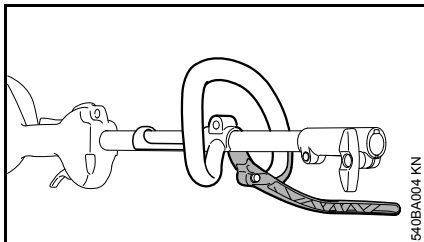

The barrier bar comes standard with the machine and must be mounted to the loop handle.

Mounting the Barrier Bar

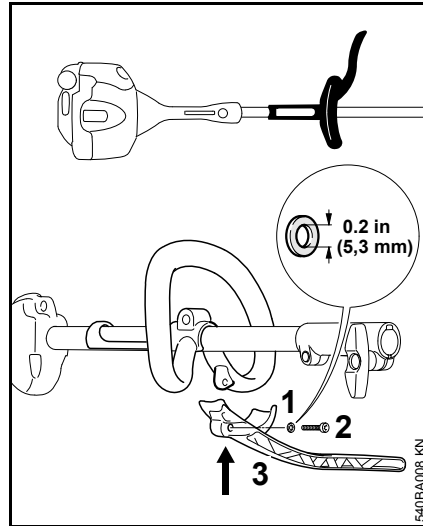

- Fit the washer (1) on the M5x23 screw (2).
- Hold the barrier bar (3) against the loop handle and insert the screw with washer.
- Tighten down the screw (2) firmly.

Leave the barrier bar permanently mounted to the loop handle.

Line up the loop handle.

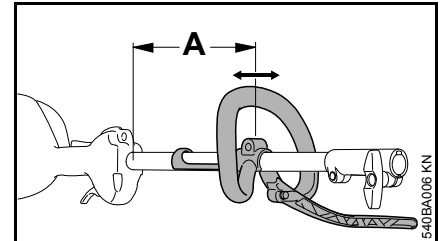

The loop handle can be adjusted to suit the height and reach of the operator and the application by changing distance (A).

- Loosen the screw on the handle.
- Slide the handle to the required position.
- Tighten down the screw so that the handle cannot be rotated on the drive tube.

Version B

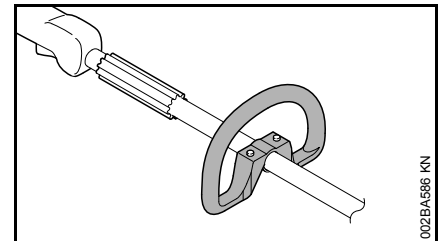

A factory-new machine comes with the loop handle already mounted.

Using the Barrier Bar

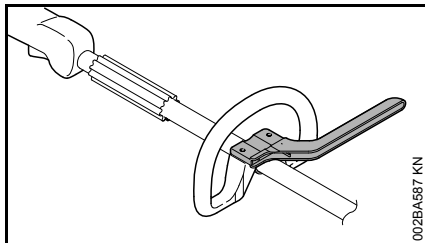

The barrier bar comes standard with the machine and must be mounted to the loop handle.

Mounting the Barrier Bar

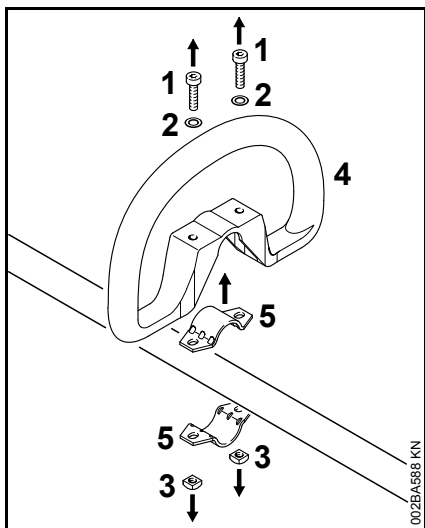

- Take out the screws (1) and remove along with washers (2) and nuts (3).
- Remove the loop handle (4) and clamps (5).

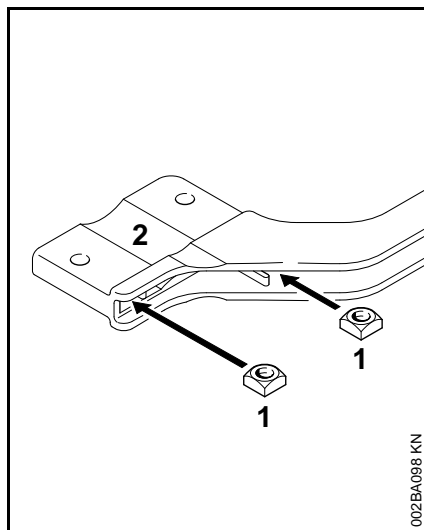

- Fit the square nuts (1) in the barrier bar (2); the holes must line up.

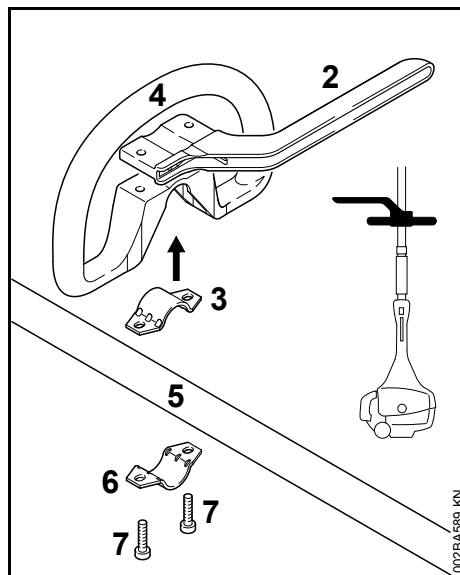

- Place the clamp (3) in the loop handle (4) and position them both against the drive tube (5).
- Place the clamp (6) against the drive tube.
- Place the barrier bar (2) in position as shown.
- Line up the holes.
- Insert the screws (7) in the holes and screw them into the barrier bar (2) as far as stop.
- Go to "Adjusting and Securing the Loop Handle".

Leave the barrier bar permanently mounted to the loop handle.

Adjusting and Securing the Loop Handle

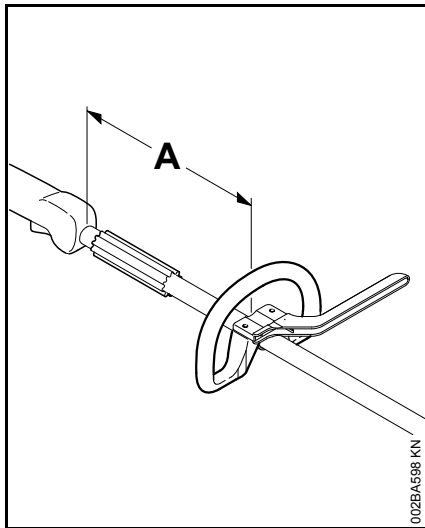

The loop handle can be adjusted to suit the height and reach of the operator and the application by changing distance (A).

- Securing the Loop Handle
- Line up the loop handle.
- Tighten down the screws firmly – lock the nuts if necessary.

Carrying ring

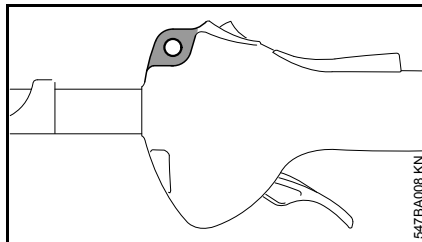

The carrying ring is integrated in the front end of the control handle.

Fuel

Your engine requires a mixture of gasoline and engine oil.

WARNING

For health reasons, avoid direct skin contact with gasoline and avoid inhaling gasoline vapor.

STIHL MotoMix

STIHL recommends the use of STIHL MotoMix. This ready-to-use fuel mix contains no benzol or lead, has a high octane rating and ensures that you always use the right mix ratio.

STIHL MotoMix uses STIHL HP Ultra two-stroke engine oil for an extra long engine life.

MotoMix is not available in all markets.

Mixing Fuel

NOTICE

Unsuitable fuels or lubricants or mix ratios other than those specified may result in serious damage to the engine. Poor quality gasoline or engine oil may damage the engine, sealing rings, hoses and the fuel tank.

Gasoline

Use only high-quality **brand-name** gasoline with a minimum octane rating of 90 – leaded or unleaded.

If your machine is equipped with a catalytic converter, you must use unleaded gasoline.



NOTICE

A few tankfuls of leaded gasoline will greatly reduce the efficiency of the catalytic converter.

Gasoline with an ethanol content of more than 10% can cause running problems in engines with a manually adjustable carburetor and should not be used in such engines.

Engines equipped with M-Tronic deliver full power when run on gasoline with an ethanol content of up to 25% (E25).

Engine oil

Use only high-quality two-stroke engine oil – preferably **STIHL HP, HP Super or HP Ultra, which are specially formulated for use in STIHL engines. HP Ultra guarantees high performance and a long engine life.**

These engine oils are not available in all markets.

Use only **STIHL 50:1 two-stroke engine oil** for the fuel mix in models with a catalytic converter.

Mix Ratio

STIHL 50:1 two-stroke engine oil: 50 parts gasoline to 1 part oil

Examples

Gasoline Liters	STIHL engine oil 50:1 Liters	(ml)
1	0.02	(20)
5	0.10	(100)
10	0.20	(200)
15	0.30	(300)
20	0.40	(400)
25	0.50	(500)

- Use a canister approved for storing fuel. Pour oil into canister first, then add gasoline and mix thoroughly.

Storing Fuel

Store fuel only in approved safety-type fuel canisters in a dry, cool and safe location protected from light and the sun.

Fuel mix ages – only mix sufficient fuel for a few weeks work. Do not store fuel mix for longer than 30 days. Exposure to light, the sun, low or high temperatures can quickly make the fuel mix unusable.

STIHL MotoMix may be stored for up to 2 years without any problems.

- Thoroughly shake the mixture in the canister before fueling your machine.



WARNING

Pressure may build up in the canister – open it carefully.

- Clean the fuel tank and canister from time to time.

Dispose of remaining fuel and cleaning fluid properly in accordance with local regulations and environmental requirements.

Fueling

Preparations

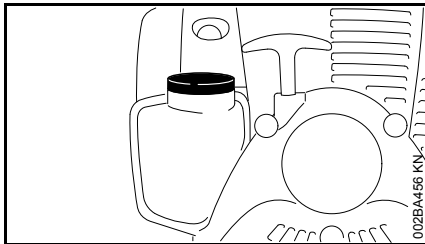

- Before fueling, clean the filler cap and the area around it to ensure that no dirt falls into the tank.
- Position the machine so that the filler cap is facing up.

A number of different filler caps are installed as standard at the factory.

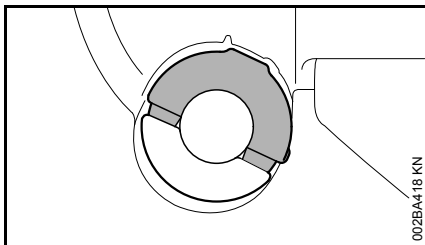

Cliplock filler cap (bayonet-type)

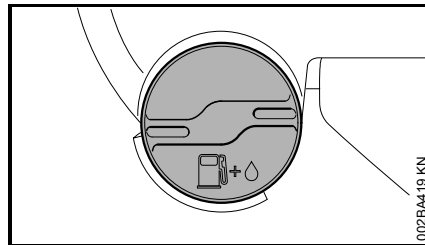

Threaded filler cap

Opening tank cap with hinged grip

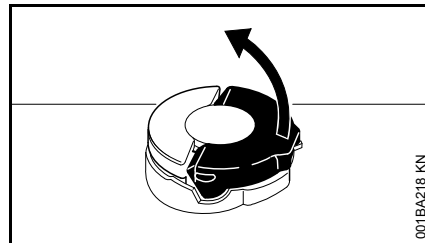

- Swing the grip to the upright position.

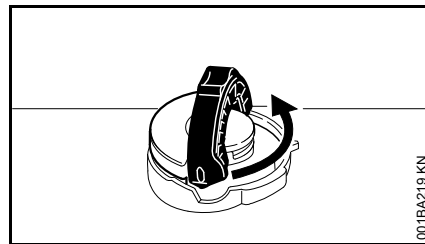

- Rotate the cap about 1/4 turn counterclockwise.

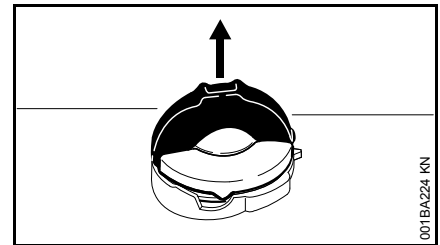

- Remove the cap.

Filling up with fuel

Take care not to spill fuel while fueling and do not overfill the tank.

STIHL recommends you use the STIHL filler nozzle for fuel (special accessory).

- Filling up with fuel

Closing tank cap with hinged grip

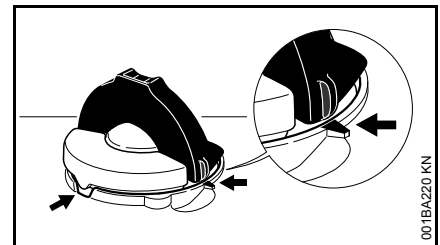

Grip must be vertical:

- Fit the cap in the opening – the marks on the cap and filler neck must line up.
- Press the cap down as far as stop.

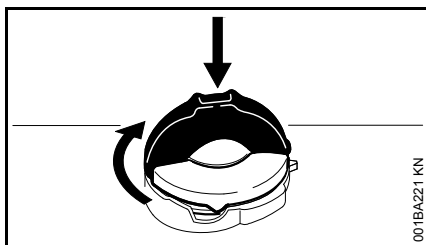

- While holding the cap depressed, turn it clockwise until it engages in position.

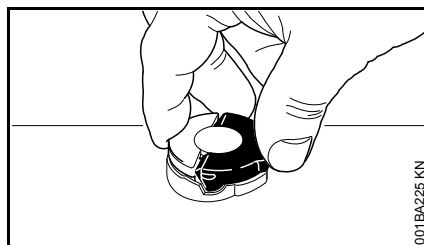

- Grip the cap – it is properly locked if it cannot be turned or removed.

If the cap can be turned or removed

Bottom of cap is twisted in relation to top:

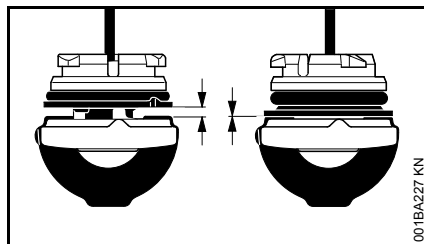

Left: Bottom of cap twisted
Right: Bottom of cap correctly positioned

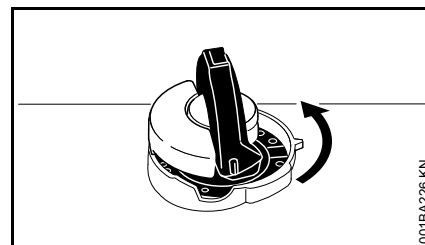

- Place the cap on the opening and rotate it counterclockwise until it engages the filler neck.
- Continue rotating the cap counterclockwise (about a quarter turn) – this causes the bottom of the cap to be turned to the correct position.
- Turn and lock the cap clockwise – see sections on "Closing" and "Checking security of cap".

Opening screw-type tank cap

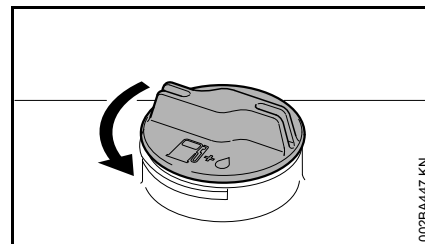

- Turn the cap counterclockwise until it can be removed from the tank opening.
- Remove the cap.

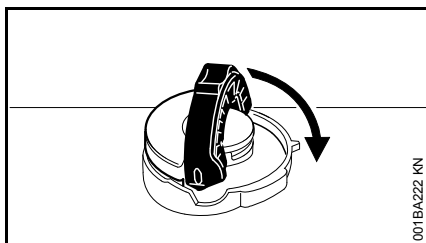

- Fold the grip flush with the top of the cap.

Checking security of cap

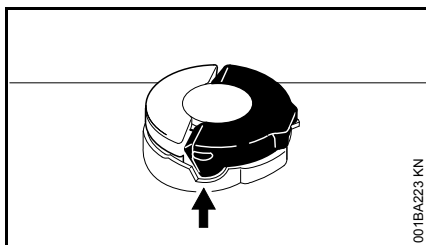

- The lug on the grip must fully engage the recess (arrow).

Filling up with fuel

Take care not to spill fuel while fueling and do not overfill the tank. STIHL recommends you use the STIHL filler nozzle (special accessory).

Closing screw-type tank cap

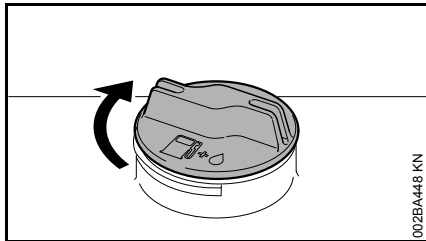

- Place the cap in the opening.
- Turn the cap clockwise as far as stop and tighten it down as firmly as possible by hand.

Starting / Stopping the Engine

Controls

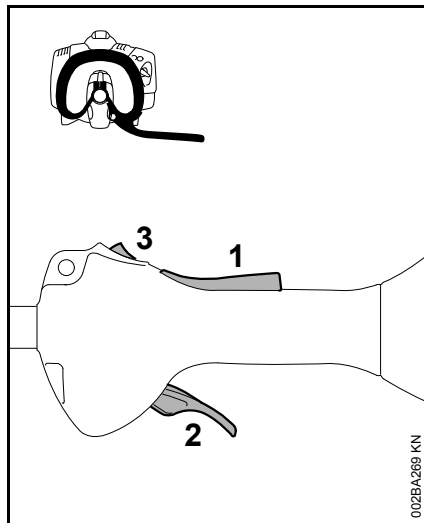

- 1 Throttle trigger lockout
- 2 Throttle trigger
- 3 Stop switch with **Run** and **0 = Stop** positions.

Function of stop switch and ignition system

The stop switch is normally in the Run position, i.e. when it is **not** depressed: The ignition is switched on – the engine is ready to start. If the stop switch is moved to the **0** position, the ignition is switched off. The ignition is switched on again automatically after the engine stops.

Starting the Engine

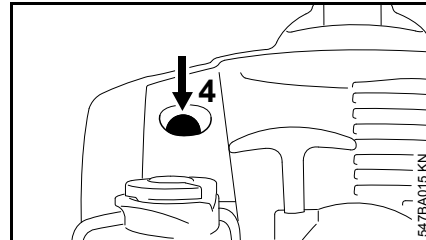

- Press the manual fuel pump bulb (4) at least five times – even if the bulb is filled with fuel.

Cold engine (cold start)

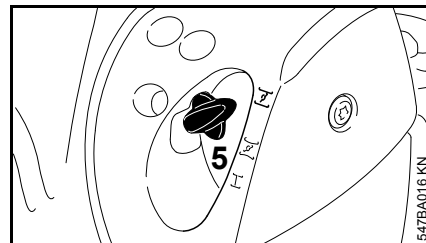

- Press in the choke lever (5) and turn it to  at the same time.

Warm engine (warm start)

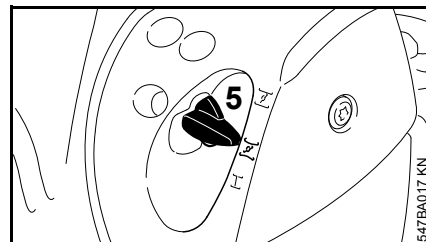

- Press in the choke lever (5) and turn it to  at the same time.

Also use this setting if the engine has been running but is still cold.

Cranking

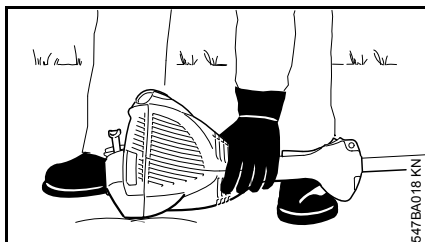

- Place the unit on the ground: Check that the working tool is not touching the ground or any other obstacles – see also "Starting / Stopping the Engine" in the KombiTool instruction manual.
- Make sure you have a safe and secure footing.
- Hold the unit **firmly** on the ground with your left hand and press down – do not touch the throttle trigger or lockout lever.



NOTICE

Do not stand or kneel on the drive tube.

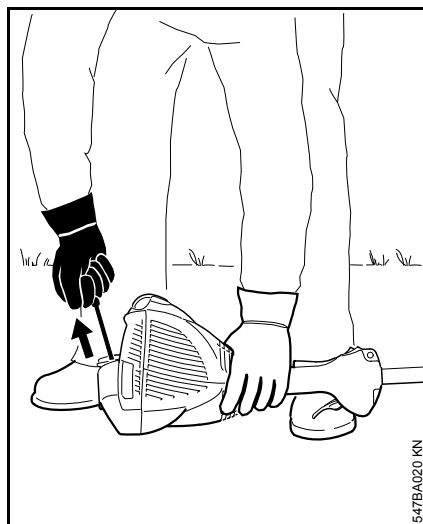

- Hold the starter grip with your right hand.

Version without ErgoStart

- Pull the starter grip slowly until you feel it engage and then give it a brisk strong pull.

Version with ErgoStart

- Pull the starter grip steadily.



NOTICE

Do not pull out the starter rope all the way – **it might otherwise break.**

- Do not let the starter grip snap back. Guide it slowly back into the housing so that the starter rope can rewind properly.
- Continue cranking until engine runs.

As soon as the engine runs

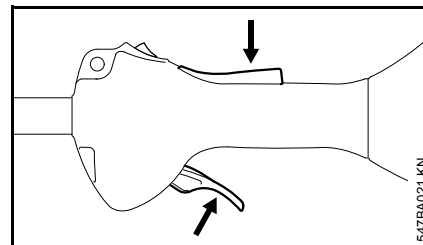

- Press down the throttle trigger lockout and open the throttle – the choke lever moves to the run position I. After a cold start, warm up the engine by opening the throttle several times.



WARNING

Make sure the carburetor is correctly adjusted. The working tool must not rotate when the engine is idling.

Your machine is now ready for operation.

Stopping the Engine

- Move the stop switch in the direction of **0** – the engine stops – release the stop switch – it springs back to the run position.

Other Hints on Starting

Engine stalls in cold start position \bar{I} or under acceleration

- Move the choke lever to \bar{II} and continue cranking until the engine runs.

Engine does not start in warm start position

- Move the choke lever to  and continue cranking until the engine runs.

If the engine does not start

- Check that all settings are correct.
- Check that there is fuel in the tank and refuel if necessary.
- Check that the spark plug boot is properly connected.
- Repeat the starting procedure.

Fuel tank run until completely dry

- After refueling, press the manual fuel pump bulb at least five times – even if the bulb is filled with fuel.
- Set the choke lever to suit the engine temperature.
- Now start the engine.

Operating Instructions

During break-in period

A factory-new machine should not be run at high revs (full throttle off load) for the first three tank fillings. This avoids unnecessary high loads during the break-in period. As all moving parts have to bed in during the break-in period, the frictional resistances in the engine are greater during this period. The engine develops its maximum power after about 5 to 15 tank fillings.

During Operation

After a long period of full throttle operation, allow the engine to run for a short while at idle speed so that engine heat can be dissipated by the flow of cooling air. This protects engine-mounted components (ignition, carburetor) from thermal overload.

After Finishing Work

Storing for a short period: Wait for the engine to cool down. Empty the fuel tank and keep the machine in a dry place, well away from sources of ignition, until you need it again. For longer out-of-service periods – see "Storing the Machine".

Cleaning the Air Filter

If there is a noticeable loss of engine power

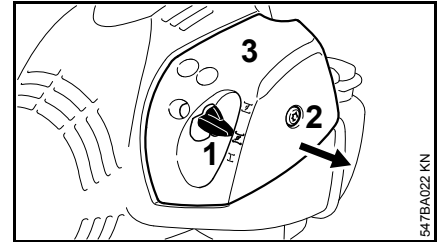

- Move the choke lever (1) to .
- Turn the screw (2) in the filter cover (3) counterclockwise until the cover is loose.
- Ease the filter cover (3) over the choke lever and lift it away.
- Clean away loose dirt from around the filter.

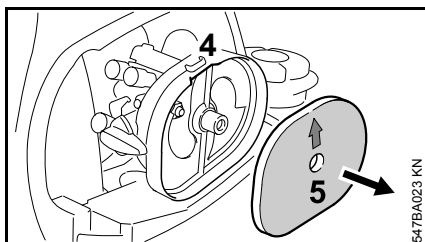

- Reach into the recess (4) in the filter housing and take out the felt filter (5).
- Fit a new felt filter element (5). As a temporary measure you can knock it out on the palm of your hand or blow it out with compressed air. Do not wash.

**NOTICE**

Replace damaged parts.

- Fit the felt filter (5) in the filter housing, make sure it is properly seated – the arrow points to the recess.
- Move the choke lever (1) to $\overline{\text{Z}}$.
- Fit the filter cover in position, making sure the screw is square. Tighten down the screw.

Adjusting the Carburetor

The carburetor comes from the factory with a standard setting.

On this machine it is no longer necessary to adjust the carburetor.

It has been set at the factory to provide an optimum fuel-air mixture in all locations and operating conditions.

Adjusting Idle Speed

Engine stops while idling

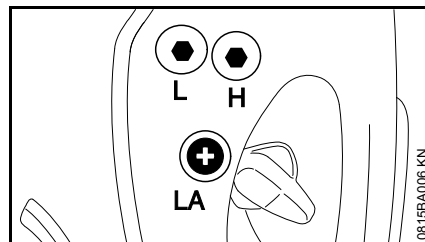

- Warm up the engine for about 3 minutes.
- Turn the idle speed screw (LA) slowly clockwise until the engine runs smoothly – the cutting attachment must not move.

Cutting attachment runs when engine is idling

- Turn the idle speed screw (LA) counterclockwise until the cutting attachment stops running and then turn the screw about another 1/2 to 3/4 turn in the same direction.

**WARNING**

If the working tool or cutting attachment continues to run when the engine is idling, have your machine checked and repaired by your servicing dealer.

Spark Plug

- If the engine is down on power, difficult to start or runs poorly at idle speed, first check the spark plug.
- Fit a new spark plug after about 100 operating hours – or sooner if the electrodes are badly eroded. Install only suppressed spark plugs of the type approved by STIHL – see "Specifications".

Removing the Spark Plug

- Shut off the engine.

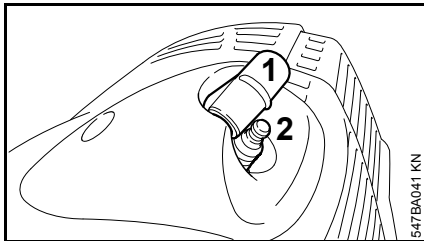

- Remove the spark plug boot (1).
- Unscrew the spark plug (2).

Checking the Spark Plug

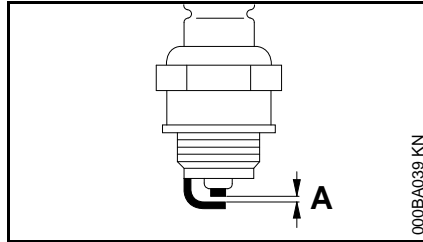

- Clean dirty spark plug.
- Check electrode gap (A) and readjust if necessary – see "Specifications".
- Rectify the problems which have caused fouling of the spark plug.

Possible causes are:

- Too much oil in fuel mix.
- Dirty air filter.
- Unfavorable running conditions.

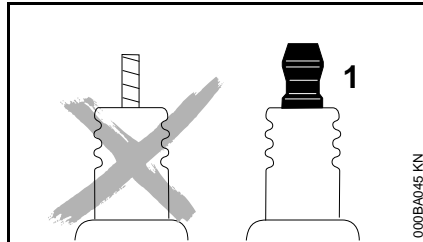

WARNING

Arcing may occur if the adapter nut (1) is loose or missing. Working in an easily combustible or explosive atmosphere may cause a fire or an explosion. This can result in serious injuries or damage to property.

- Use resistor type spark plugs with a properly tightened adapter nut.

Installing the Spark Plug

- Screw the spark plug into the cylinder.
- Press the boot firmly onto the spark plug.

Engine Running Behavior

If engine running behavior is unsatisfactory even though the air filter is clean and the carburetor is properly adjusted, the cause may be the muffler.

Have the muffler checked for contamination (carbonization) by your servicing dealer.

STIHL recommends that you have servicing and repair work carried out exclusively by an authorized STIHL servicing dealer.

Storing the Machine

For periods of 3 months or longer

- Drain and clean the fuel tank in a well ventilated area.
- Dispose of fuel properly in accordance with local environmental requirements.
- Run the engine until the carburetor is dry – this helps prevent the carburetor diaphragms sticking together.
- Thoroughly clean the machine – pay special attention to the air filter.
- Remove, clean and check the attachment. Coat metal parts with corrosion inhibiting oil.
- Store the machine in a dry and secure location. Keep out of the reach of children and other unauthorized persons.

Maintenance and Care

The following intervals apply to normal operating conditions only. If your daily working time is longer or operating conditions are difficult (very dusty work area, etc.), shorten the specified intervals accordingly.		before starting work	after finishing work or daily	after each refueling stop	weekly	monthly	every 12 months	if problem	if damaged	as required
Complete machine	Visual inspection (condition, leaks)	X		X						
	Clean		X							
Control handle	Check operation	X		X						
Air filter	Clean							X		X
	Replace								X	
Manual fuel pump	Check	X								
	Have repaired by servicing dealer ¹⁾								X	
Pickup body in fuel tank	Check							X		
	Replace					X			X	X
Fuel tank	Clean							X		X
Carburetor	Check idle adjustment – the working/cutting attachment must not move	X		X						
	Readjust idle									X
Spark plug	Readjust electrode gap							X		
	Replace after every 100 operating hours									
Cooling inlets	Visual inspection		X							
	Clean									X
All accessible screws and nuts (not adjusting screws)	Retighten									X
Safety labels	Replace								X	

¹⁾ STIHL recommends an authorized STIHL servicing dealer.

Minimize Wear and Avoid Damage

Observing the instructions in this manual helps reduce the risk of unnecessary wear and damage to the power tool.

The power tool must be operated, maintained and stored with the due care and attention described in this owner's manual.

The user is responsible for all damage caused by non-observance of the safety precautions, operating and maintenance instructions in this manual. This includes in particular:

- Alterations or modifications to the product not approved by STIHL.
- Using tools or accessories which are neither approved or suitable for the product or are of a poor quality.
- Using the product for purposes for which it was not designed.
- Using the product for sports or competitive events.
- Consequential damage caused by continuing to use the product with defective components.

Maintenance Work

All the operations described in the "Maintenance Chart" must be performed on a regular basis. If these maintenance operations cannot be performed by the owner, they should be performed by a servicing dealer.

STIHL recommends that you have servicing and repair work carried out exclusively by an authorized STIHL

servicing dealer. STIHL dealers are regularly given the opportunity to attend training courses and are supplied with the necessary technical information.

If these maintenance operations are not carried out as specified, the user assumes responsibility for any damage that may occur. Among other parts, this includes:

- Damage to the engine due to neglect or deficient maintenance (e.g. air and fuel filters), incorrect carburetor adjustment or inadequate cleaning of cooling air inlets (intake ports, cylinder fins).
- Corrosion and other consequential damage resulting from improper storage.
- Damage to the machine resulting from the use of poor quality replacement parts.

Parts Subject to Wear and Tear

Some parts of the power tool are subject to normal wear and tear even during regular operation in accordance with instructions and, depending on the type and duration of use, have to be replaced in good time. Among other parts, this includes:

- Clutch
- Filters (air, fuel)
- Rewind starter
- Spark plug

Main Parts

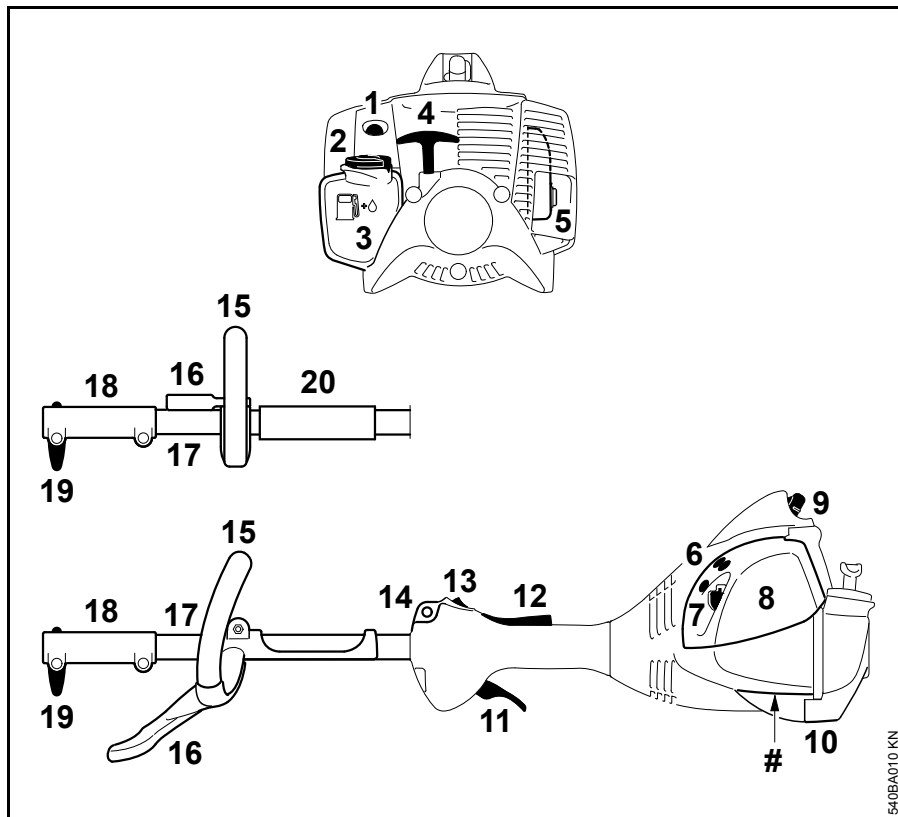

- 1 Manual fuel pump
- 2 Tank cap
- 3 Tank
- 4 Starter grip
- 5 Muffler
- 6 Carburetor adjusting screws
- 7 Choke lever
- 8 Air filter cover
- 9 Spark plug boot
- 10 Machine support
- 11 Throttle trigger
- 12 Throttle trigger lockout
- 13 Stop switch
- 14 Carrying ring
- 15 Loop handle
- 16 Barrier bar
- 17 Drive tube
- 18 Coupling sleeve
- 19 Wing screw
- 20 Sleeve
- # Serial number

540EBA010 KN

Specifications

Engine

Single cylinder two-stroke engine	
Displacement:	27.2 cc
Bore:	34 mm
Stroke:	30 mm
Engine power to ISO 8893:	0.8 kW (1.1 bhp) at 8,500 rpm
Idle speed:	2,800 rpm
Cut-off speed (rated):	10,000 rpm

Ignition System

Electronic magneto ignition	
Spark plug (resistor type):	NGK CMR 6 H
Electrode gap:	0.5 mm

Fuel System

All position diaphragm carburetor with integral fuel pump	
Fuel tank capacity:	340 cc (0.34 l)

Weight

dry, without KombiTool	
KM 56 RC with ErgoStart:	4.3 kg

Noise and Vibration Data

with KombiTools

KM 56 R, KM 56 RC

For further details on compliance with Vibration Directive 2002/44/EC see www.stihl.com/vib.

Sound pressure level L_p to EN ISO 22868, ISO 11201, ISO 11789

KM 56 RC: 93 dB(A) ... 96 dB(A)

Sound power level L_w to ISO 22868, ISO 3744

KM 56 RC: 103 dB(A) ... 107 dB(A)

Vibration measurement $a_{hv,eq}$ to ISO 11789, ISO 20643, ISO 22867, ISO 11789

Handle, left

KM 56 RC: 4.7 m/s² ... 8.5 m/s²

Handle, right

KM 56 RC: 5.8 m/s² ... 8.2 m/s²

The K-factor in accordance with Directive 2006/42/EC is 2.5 dB(A) for the sound pressure level and sound power level; the K-factor in accordance with Directive 2006/42/EC is 2.0 m/s² for the vibration measurement.

REACH

REACH is an EC regulation and stands for the Registration, Evaluation, Authorisation and Restriction of Chemical substances.

For information on compliance with the REACH regulation (EC) No. 1907/2006 see www.stihl.com/reach.

Maintenance and Repairs

Users of this machine may only carry out the maintenance and service work described in this user manual. All other repairs must be carried out by a servicing dealer.

STIHL recommends that you have servicing and repair work carried out exclusively by an authorized STIHL servicing dealer. STIHL dealers are regularly given the opportunity to attend training courses and are supplied with the necessary technical information.

When repairing the machine, only use replacement parts which have been approved by STIHL for this power tool or are technically identical. Only use high-quality replacement parts in order to avoid the risk of accidents and damage to the machine.

STIHL recommends the use of original STIHL replacement parts.

Original STIHL parts can be identified by the STIHL part number, the **STIHL** logo and the STIHL parts symbol  (the symbol may appear alone on small parts).

Disposal

Observe all country-specific waste disposal rules and regulations.

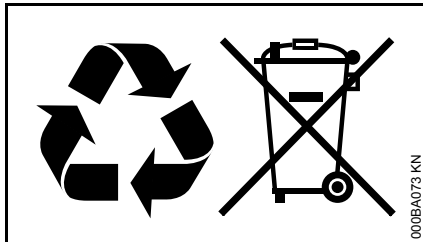

STIHL products must not be thrown in the garbage can. Take the product, accessories and packaging to an approved disposal site for environment-friendly recycling.

Contact your STIHL servicing dealer for the latest information on waste disposal.

EC Declaration of Conformity

ANDREAS STIHL AG & Co. KG
Badstr. 115
D-71336 Waiblingen

Germany

declare in exclusive responsibility that the product

Category: KombiEngine
Make: STIHL
Model: KM 56 R
KM 56 RC
KM 56 RC-E

Serial identification: 4144
Displacement: 27.2 cc

conforms to the relevant requirements of the Directives 2006/42/EC and 2014/30/EU and has been developed and manufactured in compliance with the following standards in the versions valid at the time of production:

EN ISO 12100, EN 55012,
EN 61000-6-1 (in conjunction with the following KombiTools: BF-KM, BG-KM, FCB-KM, FCS-KM, FH-KM, FS-KM, FSB-KM, HL-KM, HT-KM, KB-KM, KW-KM and SP-KM).

The KombiEngine described here may be operated only in conjunction with the KombiTools approved by STIHL for use with this KombiEngine.

Technical documents deposited at:

ANDREAS STIHL AG & Co. KG
Produktzulassung (Product Licensing)

The year of manufacture and serial number are applied to the product.

Done at Waiblingen, 28.10.2016
ANDREAS STIHL AG & Co. KG

A handwritten signature in black ink that reads 'Thomas Elsner'.

Thomas Elsner

Director Product Management and Services



0458-540-0121-C

englisch



www.stihl.com



0458-540-0121-C